

LED Illumination Units

LF2B

LUMIFA®



Universal input for global applications.
Slim, compact, easy to install.



Slim & Compact

Universal input power supply is housed in a thin, 29-mm high housing. Clear or white cover is available.

Universal Input

100 to 240V AC

Versatile universal input can be used worldwide in various applications.



12V/24V DC

12/24V DC input is suitable for batteryoperated equipment

Ideal for battery-operated equipment or applications that are required to operate in emergency, such as solar power equipment.



Two easy mounting styles

Quick and easy installation

L-shaped (optional) or U-shaped (supplied) mounting brackets available for mounting.



IP65 waterproof & dustproof



LF2B LED Illumination Units

Universal input (100 to 240V AC) and 12/24V DC input models are available.

Compact and slim design suitable for installing in various applications and also in narrow spaces. IP65 (waterproof, dustproof).

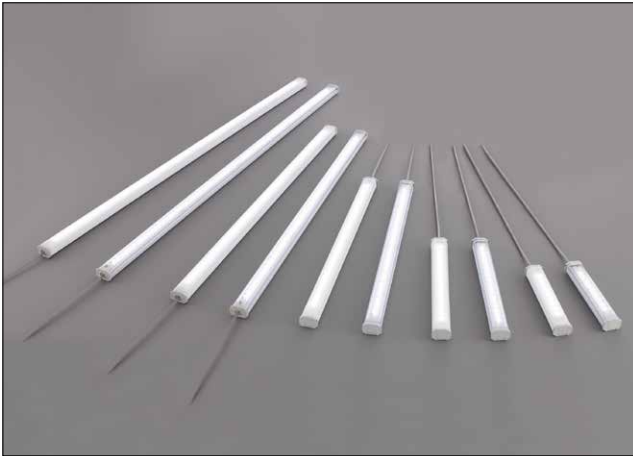

Package quantity: 1

Illumination Color	Daylight			
	Clear Cover		White Cover	
Shape				
Rated Voltage	100 to 240V AC	12/24V DC	100 to 240V AC	12/24V DC
LF2B-B (210mm)	LF2B-B3P-ATHWW2-1M	LF2B-B3P-BTHWW2-1M	LF2B-B4P-ATHWW2-1M	LF2B-B4P-BTHWW2-1M
LF2B-C (330mm)	LF2B-C3P-ATHWW2-1M	LF2B-C3P-BTHWW2-1M	LF2B-C4P-ATHWW2-1M	LF2B-C4P-BTHWW2-1M
LF2B-D (580mm)	LF2B-D3P-ATHWW2-1M	LF2B-D3P-BTHWW2-1M	LF2B-D4P-ATHWW2-1M	LF2B-D4P-BTHWW2-1M
LF2B-E (830mm)	LF2B-E3P-ATHWW2-1M		LF2B-E4P-ATHWW2-1M	
LF2B-F (1,080mm)	LF2B-F3P-ATHWW2-1M		LF2B-F4P-ATHWW2-1M	

- Use Class 2 power supply when using the LF2B as UL/c-UL listed LED illumination unit (12/24V DC only).

Part No. Development

LF2B- C 3 P - ATHWW2 - 1M

Length	Cover	Rated Voltage
B: 210mm	3: Clear	A: 100 to 240V AC
C: 330mm	4: White	B: 12/24V DC (210, 330, and 580mm lengths only)
D: 580mm		
E: 830mm		
F: 1,080mm		

Accessories

Model	Part No.	Package Quantity	Remarks
U-shaped Mounting Bracket	LF9Z-1SB21PN10	10	Supplied with LF2B. LF2B-B, -C, and D: Two brackets are supplied. LF2B-E: Three brackets are supplied. LF2B-F: Four brackets are supplied.
L-shaped Mounting Bracket	LF9Z-1SB22PN10	10	Two brackets (for right and left) are required for alternate mounting of an LF2B.

LF2B LED Illumination Units

Specifications

Model	LF2B-B (210mm)	LF2B-C (330mm)	LF2B-D (580mm)	LF2B-E (830mm)	LF2B-F (1,080mm)
Rated Voltage	100 to 240V AC, 50/60 Hz (voltage range: 90 to 264V AC) 12/24V DC (voltage range: 10.8 to 30V DC)				
Input Current (typ.) (at the rated current) (*1)	100 to 240V AC 12/24V DC	28 mA 215 mA	57 mA 409 mA	80 mA 880 mA	128 mA 165 mA
Power Consumption (typ.) (at the rated voltage)	100 to 240V AC 12/24V DC	2.2W 2.6W	4.4W 4.9W	7.8W 10.6W	12.2W 15.9W
Insulation Resistance	100MΩ min. (500V DC meggar)				
Dielectric Strength	100 to 240V AC 12/24V DC	2,000V AC, 1 minute (between live and dead parts) 1,000V AC, 1 minute (between live and dead parts)			
Vibration Resistance (damage limits)	Frequency: 5 to 55 Hz, Amplitude 0.17 mm Acceleration 20m/s ² , 2 hours each in 3 axes				
Shock Resistance (damage limits)	300m/s ² , 5 shocks each in 6 axes				
Operating Temperature	-30 to +55°C (no condensation)				
Operating Humidity	45 to 85% (no freezing)				
Storage Temperature	-35°C to +70°C (no condensation)				
Operating Atmosphere	No corrosive gas				
Life (*2)	40,000 hours (Ta = 25°C) (The total illumination life in which the illuminance maintains a minimum of 70% of the initial value.)				
Degree of Protection	IP65 (IEC 60529)				
Material	Cover: polycarbonate, End cover/cable gland: polyamide. Wire: PVC (AWG18×2C)				
Weight (approx.)	100 to 240V AC 12/24V DC	200g 175g	255g 235g	400g 370g	520g 645g

*1) 100 to 240V AC: at 100V AC, 12/24V DC: 12V DC

*2) LED life depends on the operating environment.

LED Optical Specifications

Illumination Color	Daylight									
Color Temperature	6,500K									
Model	LF2B-B (210mm)	LF2B-C (330mm)		LF2B-D (580mm)		LF2B-E (830mm)		LF2B-F (1,080mm)		
Cover	Clear	White	Clear	White	Clear	White	Clear	White	Clear	White
Luminous Flux (typ.)	235 lm	215 lm	465 lm	425 lm	935 lm	860 lm	1,380 lm	1,270	1,860 lm	1,710 lm
Reference Illuminance (typ.) at 0.5m directly below	290 lx	265 lx	540 lx	500 lx	1,065 lx	980 lx	1,385 lx	1,275 lx	1,520 lx	1,400 lx

• LED modules and illumination units may vary in illumination colors and illuminance.

Illuminance Distribution at 0.5m (clear cover)

— Half value angle: 110 degrees

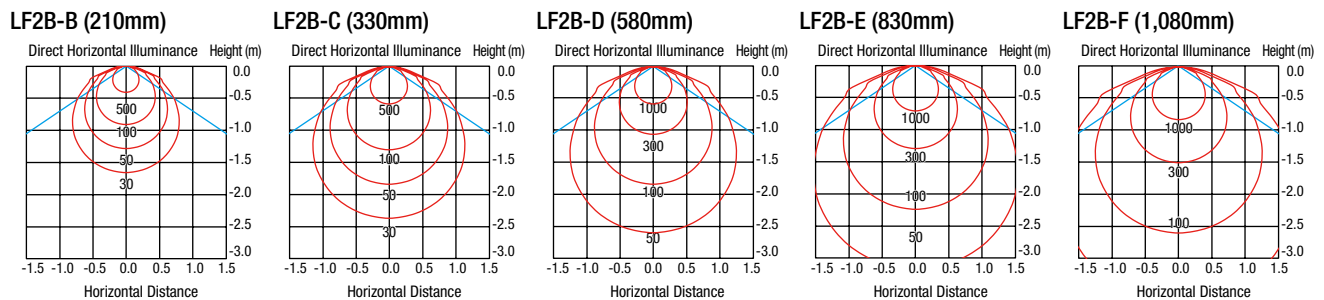

Internal Circuit

100 to 240V AC

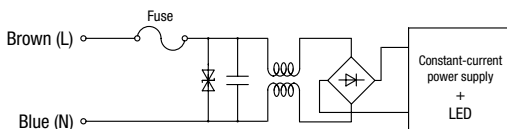

12/24V DC

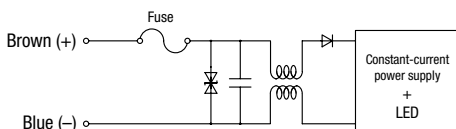

Dimensions

Without mounting bracket

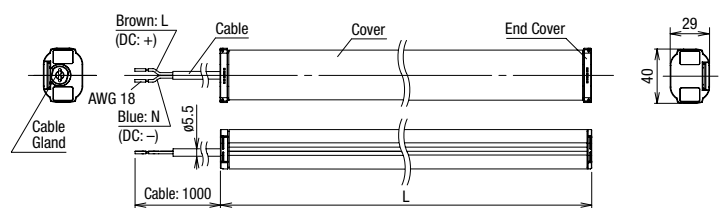

All dimensions in mm.

Part No.	L
LF2B-B*P-*THWW2-1M	210
LF2B-C*P-*THWW2-1M	330
LF2B-D*P-*THWW2-1M	580
LF2B-E*P-*THWW2-1M	830
LF2B-F*P-*THWW2-1M	1,080

With mounting bracket LF9Z-1SB21 (U-shaped brackets supplied with LED)

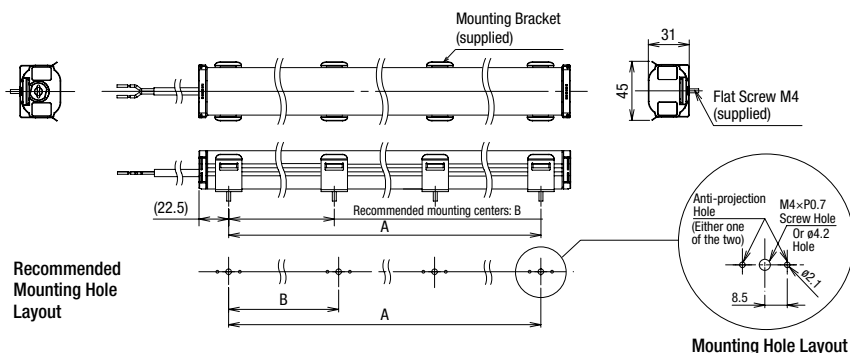

Mounting bracket LF9Z-1SB21

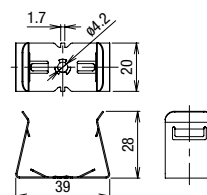

Mounting bracket LF9Z-1SB22

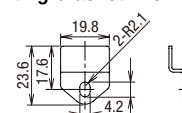

With mounting bracket LF9Z-1SB22 (L-shaped bracket purchased separately from LED)

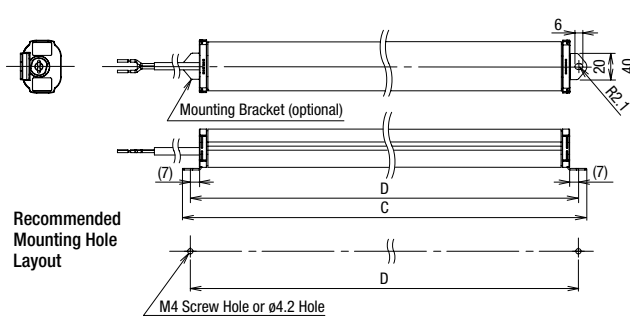

Part No.	A	B	C	D	Required No. of Mounting Bracket	
					LF9Z-1SB21 (*1)	LF9Z-1SB22
LF2B-B*P-*THWW2-1M	165	—	236	224	2	2
LF2B-C*P-*THWW2-1M	285	—	356	344		
LF2B-D*P-*THWW2-1M	535	—	606	594		
LF2B-E*P-*THWW2-1M	785	393	856	844		
LF2B-F*P-*THWW2-1M	1,035	345	1,106	1,094		

*1) Supplied with LF2B.

- APEM
- Switches & Pilot Lights
- Control Boxes
- Emergency Stop Switches
- Enabling Switches
- Safety Products
- Explosion Proof
- Terminal Blocks
- Relays & Sockets
- Circuit Protectors
- Power Supplies
- LED Illumination**
- Controllers
- Operator Interfaces
- Sensors
- AUTO-ID

LF2B

⚠ Safety Precautions

- Do not disassemble, repair, or modify LF2B. Otherwise electric shock, fire, or malfunction may occur.
- Turn off power before wiring. To prevent electric shock or damage, ensure that the wiring is correct.
- Do not stare directly into the LF2B while it is lit, and do not project the light towards other people, otherwise their eyes may be injured.
- The LF2B is general-purpose industrial electric device. Do not use with electronic equipment which may cause harm or injury to anyone or threaten life in case a malfunction or failure occurs.

Operating Instructions

- LED modules may vary in illumination colors and illuminance.
- Before designing equipment and powering up units, confirm the specifications described in the instruction sheet.
- Apply voltage within the rated values, otherwise the LED elements may be damaged.
- The LF2B is vulnerable to static electricity. Take sufficient measures for protection against static electricity and voltage surges.
- Make sure that the unit is not dropped during transportation, installation, and operation, otherwise damage may result.
- Do not pull or push the cable, otherwise damage may result. Allow sufficient slack to the cable while wiring.
- Do not apply excessive force. Do not leave a damaged unit unattended or use a damaged unit.
- Do not use or store in a location subjected to vibration and shock.
- Do not use in the following locations:
 - * Exposure to direct sunlight, near heaters, high temperatures
 - * Subject to oil, metal powder, chemicals, and corrosive gases (Plastic illumination surface: avoid iron powder and oil)
 - * Places with high humidity such as basements and greenhouses
 - * Cold storage warehouses (make sure that no freezing occurs)
- Do not loosen screws, otherwise the protection characteristics will be impaired.
- To clean the cover, use a soft cloth with water or neutral detergent. Do not use solvents such as thinners, benzene, or alkaline, otherwise discoloration, deterioration, or decrease in strength may occur.
- The edge of the cable sheath is not waterproof construction. Water may invade the LF2B in a capillary action when water splashes directly onto the cable sheath.

Die technischen Daten und sonstigen Beschreibungen dieser Druckschrift können ohne vorherige Ankündigung geändert werden.

TREICHL - ATM Electronic

Auf der Bült 10 - 12 Telefon +49-2166/9585-45
 D - 41189 Mönchengladbach Telefax +49-2166/9585-47
 E-Mail: service@atm-treichl.de Internet: www.atm-treichl.de